

70mm Outer Frame 101228
 Steel Box 2.5mm 113378
 Steel Box 1.2mm 113378
 Steel P Section 113371

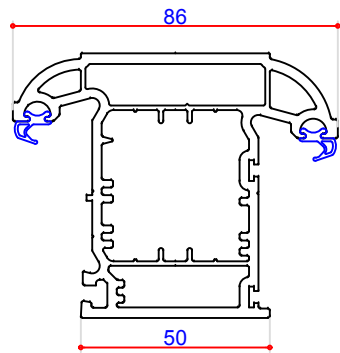

86mm T Mullion 102302
 Steel Box 2.5mm 113378
 Steel Box 1.2mm 113378
 Steel P Section 113371

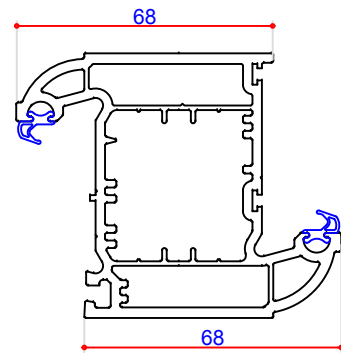

86mm Z Mullion 102303
 Steel Box 2.5mm 113378
 Steel Box 1.2mm 113378
 Steel P Section 113371

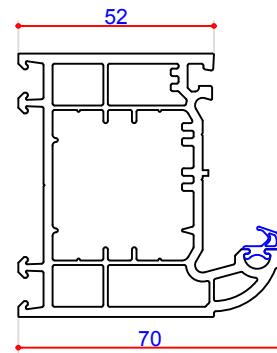

70mm Outer Frame 101161
 Steel Box 2.5mm 113378
 Steel Box 1.2mm 113378
 Steel P Section 113371

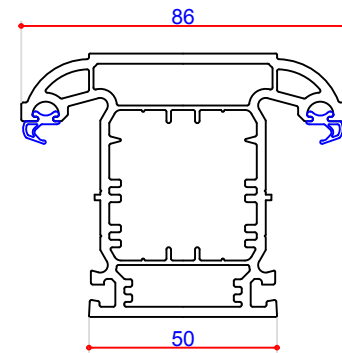

86mm T Mullion 102263
 Steel Box 2.5mm 113378
 Steel Box 1.2mm 113378
 Steel P Section 113371

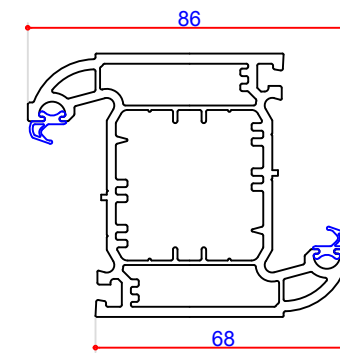

86mm Z Mullion 102262
 Steel Box 2.5mm 113378
 Steel Box 1.2mm 113378
 Steel P Section 113371

Styrofoam LBH-X Grade - Close Tolerance
 #Non Veka Part - Available from:
 Panel Systems Ltd
 Units 3-9 Welland Close
 Parkwood Ind Est
 Rutland Road
 Sheffield
 S3 9QY
 Tel: 0114 2752881
 Fax: 0114 2768807

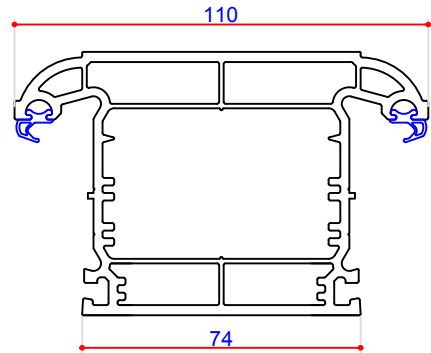
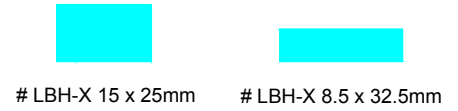

110mm Midrail 102264
 Steel Box 113376
 Aluminium Box 115286

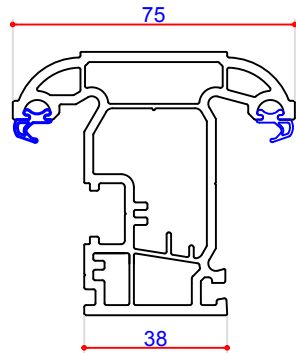

75mm Casement Sash 103264
 Steel Box 113039
 Steel P Section 113272
 Steel Channel 113387

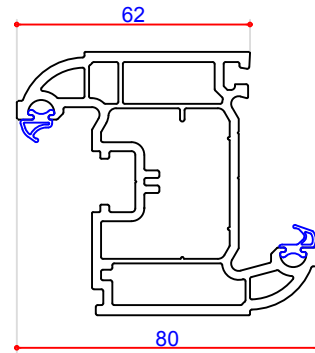

80mm Tilt & Turn Sash 103267
 Steel L Section 113373
 #LBH-X 8.5 x 32.5mm with No Steel



112355
 T+T & Door Weatherseal/Repair



112384
 4mm Repair Gasket

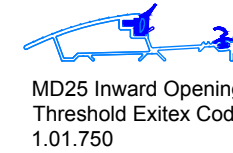

MD25 Inward Opening Threshold Exitex Code 1.01.750

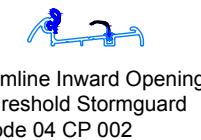

Slimline Inward Opening Threshold Stormguard Code 04 CP 002

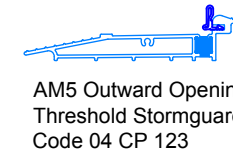

AM5 Outward Opening Threshold Stormguard Code 04 CP 123

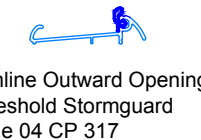

Slimline Outward Opening Threshold Stormguard Code 04 CP 317

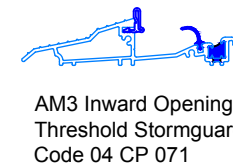

AM3 Inward Opening Threshold Stormguard Code 04 CP 071

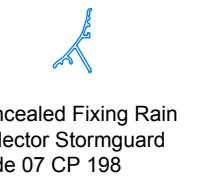

Concealed Fixing Rain Deflector Stormguard Code 07 CP 198

Aluminium Thresholds - NON Veka parts, available from:

The Stormguard Group
 Regency Mill
 Chester Rd
 Macclesfield
 Cheshire
 SK118HR
 T: 01625 613311
 F: 01625 614434
 E: orders@stormguard.co.uk

Exitex Ltd
 Mountpleasant
 Dundalk
 Ireland
 T: 00353 42 9371244
 F: 00353 42 9371221
 E: info@exitex.com

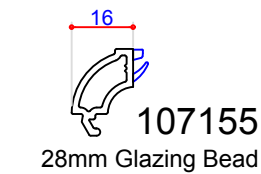

107155
 28mm Glazing Bead

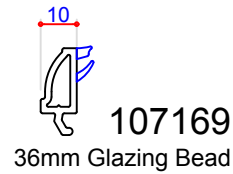

107169
 36mm Glazing Bead

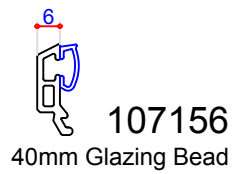

107156
 40mm Glazing Bead

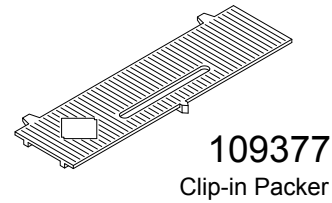

109377
 Clip-in Packer

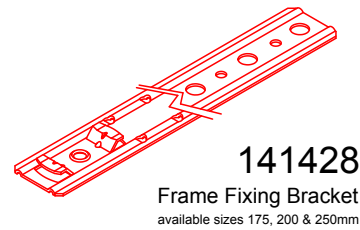

141428
 Frame Fixing Bracket
 available sizes 175, 200 & 250mm

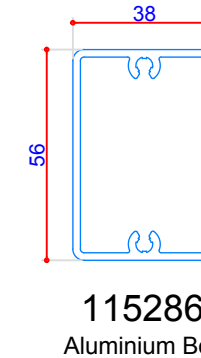

115286
 Aluminium Box

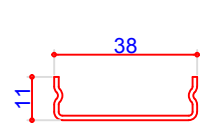

Steel U Channel 113321

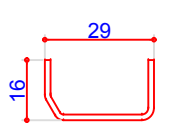

Steel U Channel 113387

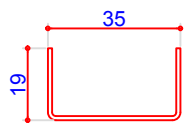

Steel U Channel 113377

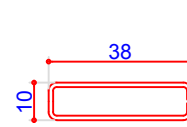

Steel Box 113041

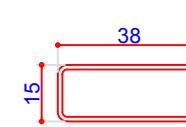

Steel Box 113073

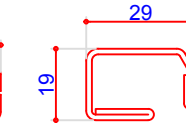

Steel Box 113039

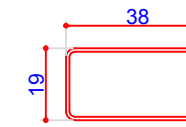

Steel Box 113245

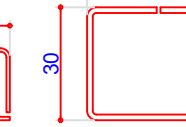

Steel Box 113271

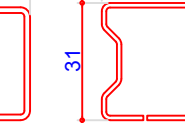

Steel Box (1.2mm) 113378

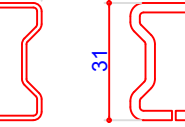

Steel Box (2.5mm) 113378

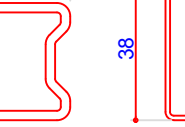

Steel Box 113376



Steel P Section 113371

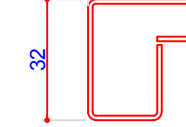

Steel P Section 113372

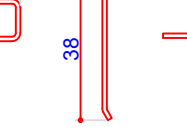

Steel L Section 113373

KEY:

- PVC Profile
- Gasket
- Steel
- Aluminium
- LBH-X

DO NOT SCALE the drawings shown are visual representations only. VEKA PLC has the right to alter the designs, specification & descriptions without prior notice as part of our policy of continuous development and improvements.

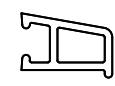

109122
 Drip Bar
 End Cap 109141



709192
 Drip Bar
 End Cap 709223



109030
 Drip Bar
 End Cap 109140



109045
 Eurogroove Infill

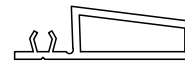

109231
 Snap-on Bead

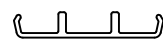

105173
 Universal Frame Infill

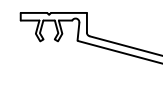

109230
 Snap-on Head Drip



110104
 Cill Frame Extension

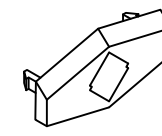

109267
 Drainage Cap